



Standard Specifications

MX700N-D

1st ed. 03-Apr-15

2nd ed. 02-Oct-20

Kawasaki Heavy Industries, Ltd.
Robot Business Division

Specification number : 90151-0063DEB

Robot specifications

1. Model	MX700N-D																						
2. Type	Articulated robot																						
3. Degree of freedom	6 axes																						
4. Max. payload	700 kg																						
5. Max. reach	2,540 mm																						
6. Position repeatability	±0.1 mm (wrist flange surface) conforms to ISO 9283																						
7. Axis specification	<table border="1"> <thead> <tr> <th>Operating axis</th> <th>Motion range</th> <th>Max. speed</th> </tr> </thead> <tbody> <tr> <td>Arm rotation (JT1)</td> <td>±180°</td> <td>65°/s</td> </tr> <tr> <td>Arm out-in (JT2)</td> <td>+90° ~ -45°</td> <td>50°/s</td> </tr> <tr> <td>Arm up-down (JT3)</td> <td>+20° ~ -130°</td> <td>45°/s</td> </tr> <tr> <td>Wrist swivel (JT4)</td> <td>±360°</td> <td>50°/s</td> </tr> <tr> <td>Wrist bend (JT5)</td> <td>±110°</td> <td>50°/s</td> </tr> <tr> <td>Wrist twist (JT6)</td> <td>±360°</td> <td>95°/s</td> </tr> </tbody> </table>		Operating axis	Motion range	Max. speed	Arm rotation (JT1)	±180°	65°/s	Arm out-in (JT2)	+90° ~ -45°	50°/s	Arm up-down (JT3)	+20° ~ -130°	45°/s	Wrist swivel (JT4)	±360°	50°/s	Wrist bend (JT5)	±110°	50°/s	Wrist twist (JT6)	±360°	95°/s
Operating axis	Motion range	Max. speed																					
Arm rotation (JT1)	±180°	65°/s																					
Arm out-in (JT2)	+90° ~ -45°	50°/s																					
Arm up-down (JT3)	+20° ~ -130°	45°/s																					
Wrist swivel (JT4)	±360°	50°/s																					
Wrist bend (JT5)	±110°	50°/s																					
Wrist twist (JT6)	±360°	95°/s																					
8. Load capacity of wrist	<table border="1"> <thead> <tr> <th></th> <th>Max. torque</th> <th>Moment of inertia*</th> </tr> </thead> <tbody> <tr> <td>JT4</td> <td>5,488 N·m</td> <td>600 kg·m²</td> </tr> <tr> <td>JT5</td> <td>5,488 N·m</td> <td>600 kg·m²</td> </tr> <tr> <td>JT6</td> <td>2,744 N·m</td> <td>388 kg·m²</td> </tr> </tbody> </table> <p>Note * Each value in this table shows allowable moment of inertia of JT4/JT5/JT6 when max. allowed torque is applied to each axis. If more detailed data is required for your application, please contact Kawasaki.</p>			Max. torque	Moment of inertia*	JT4	5,488 N·m	600 kg·m ²	JT5	5,488 N·m	600 kg·m ²	JT6	2,744 N·m	388 kg·m ²									
	Max. torque	Moment of inertia*																					
JT4	5,488 N·m	600 kg·m ²																					
JT5	5,488 N·m	600 kg·m ²																					
JT6	2,744 N·m	388 kg·m ²																					
9. Mass	2,860 kg (without options)																						
10. Mounting	Floor mounting																						
11. Installation Environment	Ambient Temperature: 0 ~ 45 °C																						
	Relative Humidity: 35 ~ 85 % (with no dew condensation)																						
12. Color	Munsell 10GY9/1 or equivalent																						
13. Built-in utilities	Pneumatic piping (φ12×2 lines)																						
	Wirings for valves to operate the hand (DC24V × 7 circuits)																						
14. Options	Mechanical stopper	Adjustable mechanical stoppers JT1/JT2/JT3																					
	Limit switch	JT1, JT2, JT3																					
	Solenoid valves	Double solenoid valve 3 circuits/2 circuits																					
	Air cleaning unit	Filter, Regulator, Lubricator																					
	Optional harness	Type C0, Type E0(NPN), Type E0(PNP), Type H0(NPN), Type H0(PNP)																					
	Servo on lamp	Comply UL Standard																					
	Jig for conveyance	Fork pockets																					
	Color																						

Consult Kawasaki about maintenance parts and spare parts.

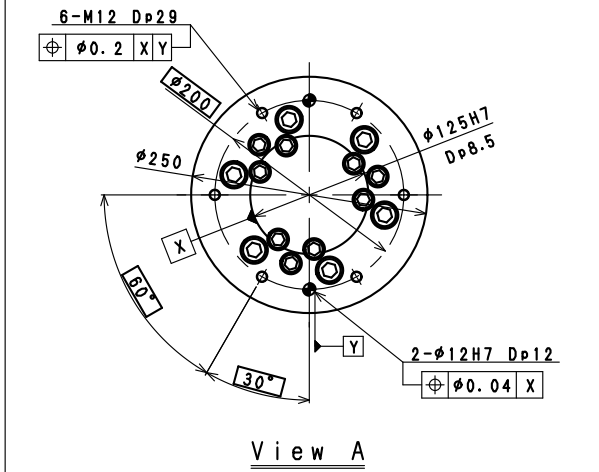
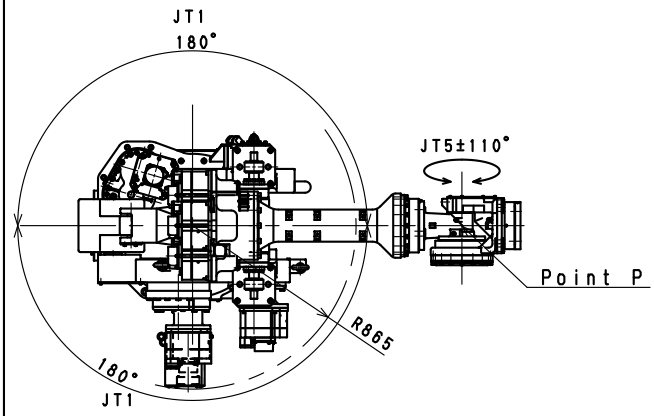
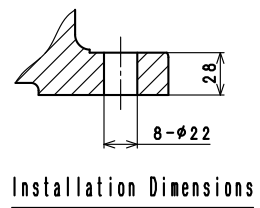
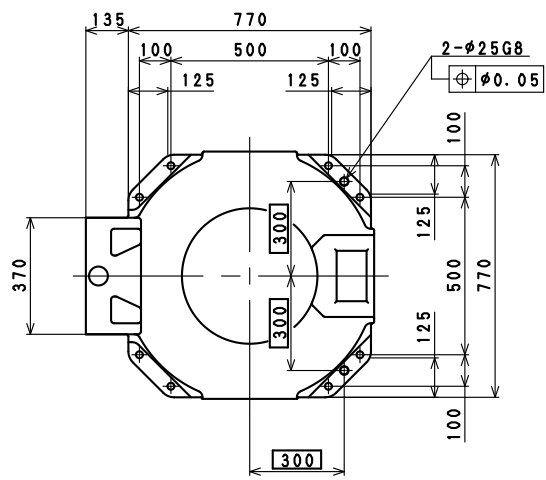

Working range based on point P

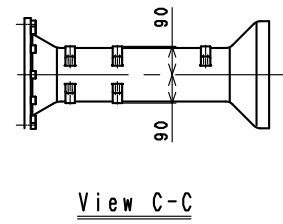
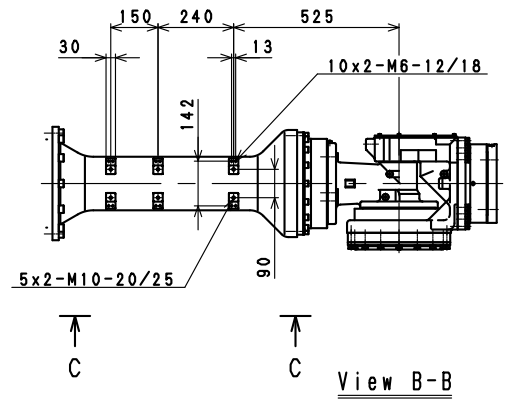
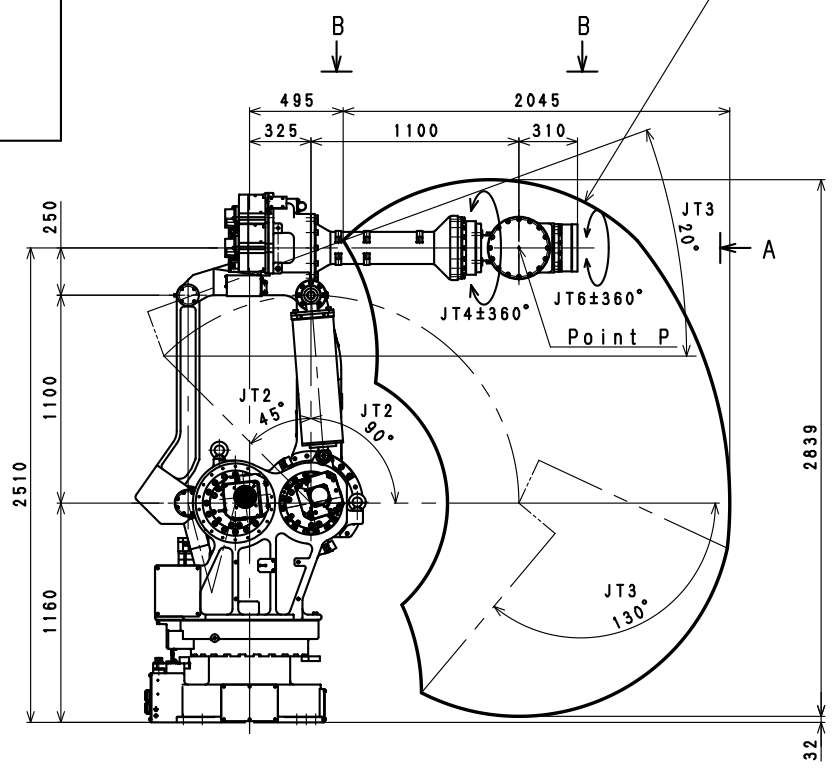

MX700N
WORKING RANGE

